MFP Range 4-28 Zone Fire Alarm Control Panels

INSTALLATION INSTRUCTIONS

PLEASE READ THESE INSTRUCTIONS CAREFULLY BEFORE INSTALLING AND/OR MAINTAINING THIS EQUIPMENT

These instructions are general and cannot be considered to cover every aspect of fire alarm installation.

We recommend you read BS 5839: Pt 1: 1988 "Fire Detection and Alarm Systems for Buildings" (available at your local reference library or from the BSI).

No responsibility can be accepted by the manufacturers or distributors of this range of fire panels for any misinterpretation of an instruction or guidance note or for the compliance of the system as a whole.

Contact the Fire Officer concerned with the property at an early stage in case he has any special requirements. We strongly recommend that a suitably qualified and competent person is consulted in connection with the design of the Fire Alarm system.

The manufacturers policy is one of continuous improvement and we reserve the right to make changes to product specifications at our discretion and without prior notice. E&OE.

IMPORTANT NOTES

- 1. This equipment must only be installed and maintained by a suitably skilled or technically competent person.**
- 2. This equipment is a piece of class 1 equipment and MUST BE EARTHED.**
- 3. To meet the requirements of BS 5839 Part 1 1988 Amendment N° 1 (Effective Jan. 1991) manual call points must still operate when any detectors are removed from their bases. This is mandatory whether or not the detectors have locking or shorting devices. To comply with this directive either the manual call points must be wired before the detectors, incurring extra installation expense, or detector bases with diodes fitted must be used to ensure continuity when detectors and call points are mixed. The MFP range of panels will operate in this way and will give a distinct fault indication when a head is removed.**
- 4. If you connect the battery leads in reverse you will blow the battery fuse and you RISK DAMAGING THE PANEL. The fault is factory detectable and you WILL BE CHARGED FOR THE REPAIR.**
- 5. If the Battery/Power Supply fault light comes on whilst the Green Mains On light is lit then it usually means that the battery is either discharged or faulty (see page 9 inside for details).**

Important Notes	Page 1	Testing The Panel	Page 5
Guide to System Design	Page 2	Ancillary Facilities	Page 7
Installation - First Fix	Page 3	Troubleshooting	Page 9
Installation - Second Fix	Page 4	Panel Specification	Page 10

■ GUIDE TO FIRE ALARM SYSTEM DESIGN

CONTROL PANEL

The fire panel must be sited internally, in an area where it is readily accessible by staff on duty and the fire brigade. The area should be clean and dry and you should take into account any likelihood of tampering or vandalism. The ambient light and sound levels should allow the status of the indicators to be clearly seen and the internal sounder to be heard. Full details can be found in BS 5839: Pt1: 1988: Section 15.3 "Fire Detection and Alarm Systems for Buildings".

SOUNDERS

All sounders must be polarised. Unpolarised sounders will show a sounder fault.

The most common sounders are bells and electronic sounders. *Motorised sirens MUST NOT be used on these panels*. The same type of sounder must be used throughout the building and it must be distinctive so that the sound associated with a fire alarm is easily recognised.

The minimum sound level is 65 dB or 5 dB above any background noise likely to persist for longer than 30 seconds. The fire alarm must be audible in every part of the building. For sleeping accommodation the sound level should be 75 dB at the bedhead if sleeping people with normal hearing are to be wakened.

Four sounder circuits are provided. Not all need be used, but at least two circuits should be connected with at least one sounder on each. Sounders should be wired in approximately equal numbers on each circuit.

MANUAL CALL POINTS

Manual Call Points should be sited on all exit routes especially on landings and staircases and by final exit doors, with a maximum distance from any place in the building to a Call Point of 30 metres, (less distance in high risk areas). They should ideally be sited 1.4 metres above the floor and in a conspicuous and easily reached position. Any number of call points can be connected on each zone.

Important: Many call points are now supplied with a resistor already fitted. This can be determined by measuring with a good quality Ohmmeter. The call point should normally measure open circuit, and 470 or 680 ohms when activated. If the call points are not of this type then a series resistor must be connected in series with the call point in order to ensure that an alarm condition will occur. See figure 1 for fitting diagram.

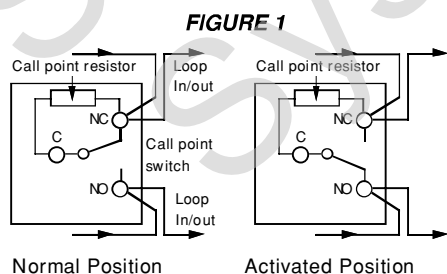

Note: Resistors are not included with the panel but are available from electronic component suppliers. Failure to include this resistor will cause the panel to show a short circuit fault indication when the call point is operated. This also applies to any other form of switch used to trigger the detector circuits. This panel will work with resistance values from 470 to 680 ohms fitted. The resistors must be rated half watt.

N.B. It is possible to disable the short circuit = fault condition for each zone so that a short circuit will cause a fire condition (see page 7 for further details).

SMOKE AND HEAT DETECTORS

Up to 20 heat or smoke detectors can be fitted on each zone.

Smoke Detectors: There are two types of smoke detector, Ionisation and Optical. Ionisation are generally quickest at detecting a clean burning fire. Optical are quickest at detecting smouldering fires. Neither one is better than the other in all circumstances. Some Fire Authorities will only allow one kind and you should check with the Fire Officer.

Do not site smoke detectors in draughts. Siting of the detectors depends on many factors and BS5839: Pt1: 1988 "Fire Detection and Alarm Systems for Buildings" should be consulted for full details of spacing, etc.

Dirt, dust, smoke, steam, water vapour and condensation will affect the detectors, causing false alarms and the need for frequent cleaning. Under these conditions, the use of heat detectors should be considered (see below). If in doubt, consult the Fire Officer. **Note:** Building work causes adverse conditions. If possible, remove all detectors from site until work is completed to avoid contamination.

Heat Detectors: These are used in places where smoke detectors are not practical, such as kitchens and boiler rooms. There are two kinds, Fixed Temperature and Rate of Rise. Fixed Temperature Detectors are used where sudden rises in temperature which would cause alarms are common, such as in kitchens. Rate of Rise Detectors are used elsewhere as they generally respond faster than Fixed Temperature Detectors.

BATTERIES

For the emergency stand-by power supply, two good quality 12V sealed lead acid batteries (connected in series) should be used. They should be of a type that have at least four years life under normal conditions.

The capacity of the batteries used will depend on the required stand-by time (See 'Panel Specification', page 10, for stand-by times).

For battery connection details, see 'Installation - Second Fix', page 5. Always dispose of used batteries according to the battery manufacturers instructions.

Important: This range of panels features a sophisticated battery monitoring circuit which, instead of monitoring the current being passed through the batteries, actually detects their condition. Consequently, a discharged battery or one with deteriorating cells will show a BATTERY/POWER SUPPLY FAULT. Test with brand new, fully charged batteries.

CABLE TYPES

Sounders must be wired in cable complying with, for example, BS6207 (MICC or 'pyro'). Detectors may be wired in cable complying with, for example, BS6004 (PVC) or BS6207. Ensure you comply with BS5839 Pt1 regarding siting, installation and choice of cables.

NOTES ON THE OVERALL DESIGN

Decide on the position of all parts and mark the plans accordingly. Get the Fire Officer to check them to ensure any special requirements he may have are complied with (he has the right to refuse a fire certificate until he is satisfied).

Note: To fully comply with BS5839 Manual Call points must still operate when any of the Detectors are removed. This can be accommodated by wiring Call Points first or by using detector bases with continuity diodes fitted. Some manufacturers supply bases with integral diodes.

Note: Never spur off any detector or sounder cable run, as the spur wiring will not be monitored correctly.

INSTALLATION - FIRST & SECOND FIX

TYPICAL ZONE LOOP CIRCUIT (Mixed order call points and detectors)
CPR = call point resistor (470 Ω - 680 Ω - normally supplied with call point)

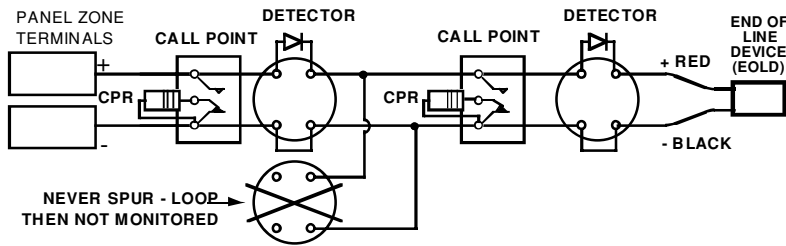
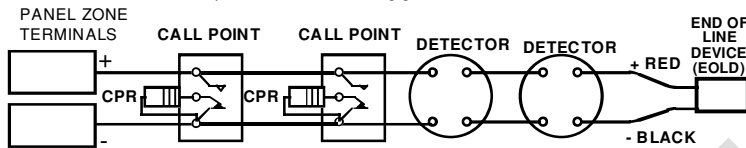

FIGURE 2

Typical wiring arrangements for detector and sounder circuits

ZONE LOOP CIRCUIT (Call points wired before detectors) detector base diodes not needed -
If detector removed then open circuit fault warning given.



TYPICAL SOUNDER CIRCUIT

Sounders must be polarised.

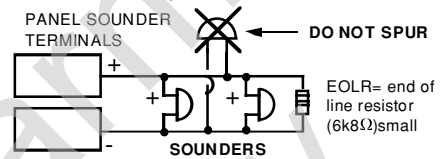

*THREE WIRE SYSTEM Combined detector and sounder loops using common 0v conductor.

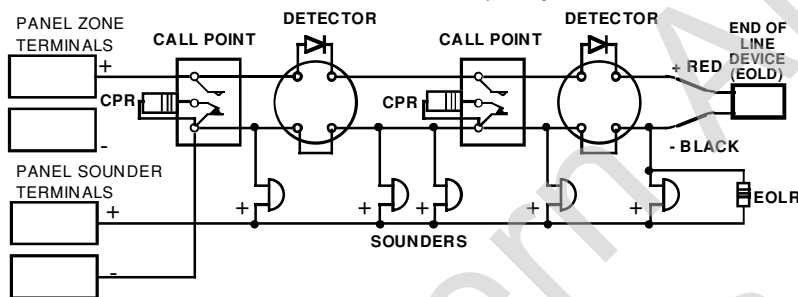

***IMPORTANT** Some cautionary points about the three wire system illustrated.

- This configuration is used to utilise existing wiring when refurbishing an existing system. New installations are not usually planned in this manner.
- The system must be connected so that if any head is removed then all the sounders will still operate.
- Since the common wire carries all the current for the sounders and the detectors it should be of low impedance and connected to the sounder circuit 0v. Check that when any detector is triggered that it will not be inadvertently reset by the sounder current in an alarm condition.

FIRST FIX

Run cables and fix the smoke and heat detector bases and call points. Fit sounders.

Take the control panel out of its box and undo the two screws at the top using the key provided in the accessory pack.

Hinge the lid down 180° and remove the earth connection. Locate the connector plug(s) on the main printed circuit board. Grasp the wires to the plug(s) firmly and pull the connector off the board. Then hinge the lid back 90° and lift the front panel off.

The front panel may be removed from site until work is completed if it is likely to get damaged.

Fix the base of the fire panel securely to the wall using the mounting holes provided (see 'A', figure 3). The mounting holes are suitable for use with No. 8 round head or countersunk woodscrews. Assess the condition and construction of the wall and use a suitable screw fixing.

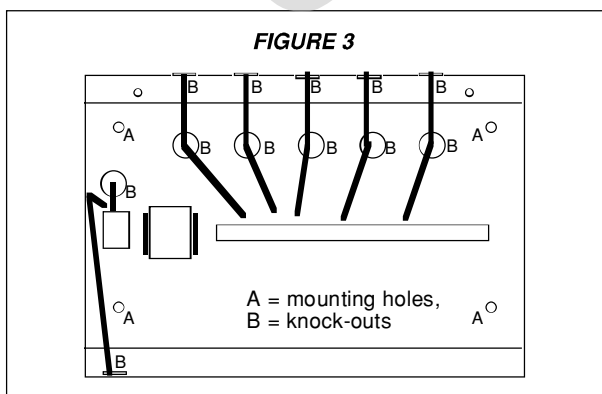

FIGURE 3

Any dust created during the fixing process must be kept out of the fire panel, and great care must be taken not to damage any wiring or components.

All mains wiring should be provided in accordance with the current edition of the IEE Wiring Regs, 16th. Ed. (BS 7671, 1993) or in accordance with the relevant national wiring rules.

The general requirement for the mains supply to this equipment is fixed wiring, using three core cable, not less than 0.75mm² or a suitable three conductor system, fed from an isolating switch fuse spur, fused at 3A. This should be marked "FIRE ALARM: DO NOT SWITCH OFF" and should be secure from unauthorised operation.

The mains connection is made inside the fire panel on the fused mains terminal block only. Connection must not be made to the mains supply using a plug and socket. The mains supply should be exclusive to the fire panel. (Full details can be found in BS5839: Pt1: 1988 section 15.3. "Fire Detection and Alarm Systems for Buildings").

The wiring of the panel should be carefully planned before starting the job. Always ensure that if a knockout is removed, that the hole is filled with a good quality cable gland.

Plan and route all of the wiring as indicated in Figure 3 by the dotted lines.

All external wiring brought into the panel should be adequately insulated with PVC, PTFE, Neoprene or other fire resistant / retardant material.

Do not use an insulation tester (Megger) with any detectors, sounders, continuity diodes or control equipment of any kind connected as the 500 volt test voltage will destroy all of these devices totally.

On some smoke detector bases removing the head open circuits one connection, therefore to test continuity of circuit it may be necessary to 'link out' these bases. **N.B.** If continuity diodes are to be used in detector bases then they must be fitted in the correct orientation as shown in the Detector base details (see Figure 4).

FIGURE 4

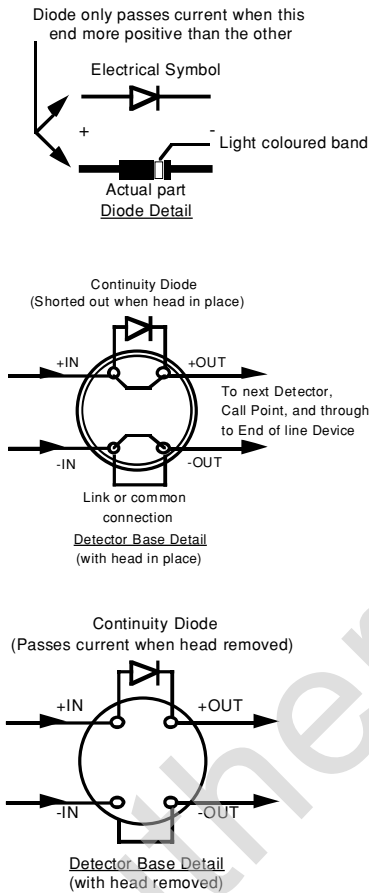

The diode must be connected so that it is shorted out by the internal connections of the head when the head is in place, and provides a path for the current in the loop when the head is removed. Incorrect fitting will not cause damage but will cause malfunctions of the system. (See troubleshooting - page 9)

DO NOT connect the wiring into the terminal block in the panel until you have tested the panel.

Do not leave any part of the fire alarm system where it may become dusty or damp (due to any building work such as plastering, painting, carpet fitting, etc) as this will result in possible malfunctions, including false alarms.

SECOND FIX

Only to be carried out when all building work is complete and no more dust will be raised.

Check the panel is isolated from the mains. Remove the batteries and lid of the panel to avoid accidental damage whilst connecting the wires.

Having checked the wiring and panel remove the End of Line Devices (small plastic covered circuit board with flying leads) and Resistors from the terminal block and insert them across the terminals of the last detector and the last sounder respectively in each circuit.

Next, connect all sounders and plug in all detectors. Check the wiring continuity with a multi-meter (do not test with an insulation tester (Megger)).

Ensure that Manual Call Points have resistors fitted (see page 2), otherwise a short circuit fault will occur instead of a Fire condition.

When you are sure all connections are firm with no insulation trapped and no bare wires, replace the front of the panel and re-attach the relevant loom connectors.

Make sure that the earth wire is connected back up.

Next, power the system up by connecting the batteries. To determine the type and size of batteries required, refer to pages 2 and 10.

Connect the batteries in series as shown in Figure 5. Always be sure of the connections before you make them as incorrect connection will blow the battery fuse (F5) and may damage the panel.

Position the batteries in the panel as shown in Figure 6. Once the batteries are connected, close up the panel, fit the two lid screws and then energize the mains supply. The panel should now be in the Normal mode. If not see troubleshooting guide page 9.

Now test the system is fully operational (See 'Testing The Panel', page 5).

If the number of zones of the panel is to be increased, refer to the relevant zone kit for installation instructions.

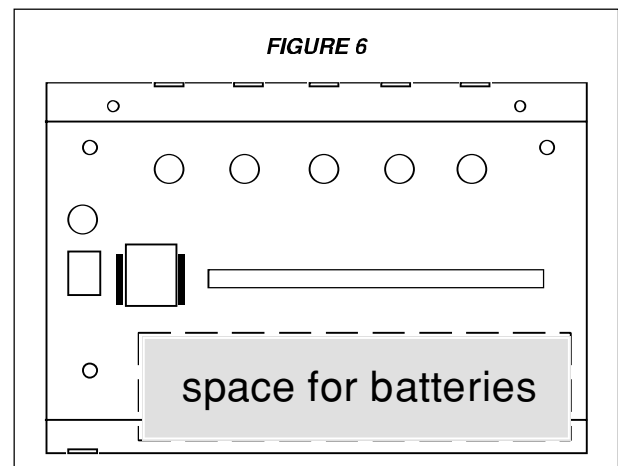
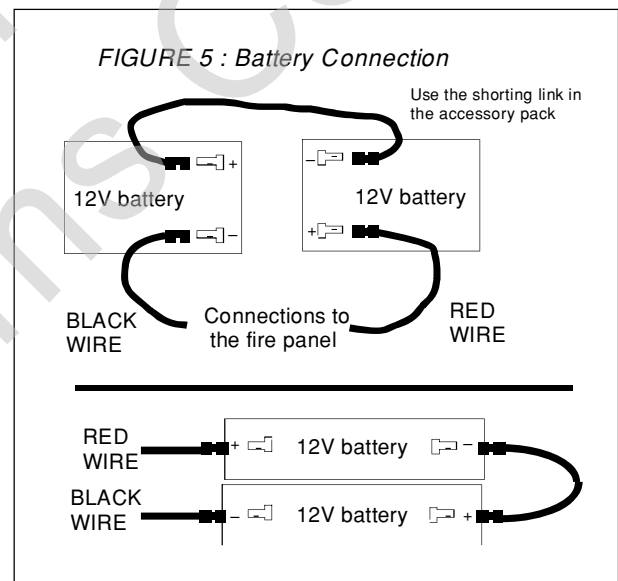

■ TESTING THE PANEL

THE PANEL CAN BE TESTED BEFORE CONNECTING UP

When testing or maintaining the panel with the panel lid open, always - where possible - isolate the mains and disconnect the batteries.

Note: Non of the controls will be operative unless the keyswitch is in the ARM CONTROLS position.

Make sure the End of Line Devices are fitted in the detector terminals and End of Line Resistors are fitted in the sounder terminals.

Do not connect any wires except the mains feed.

Hook on the panel front and plug the connector onto the circuit board (PL4). The red wire in the plug loom goes to the right hand side as marked on the circuit board.

Install batteries of suitable capacity in the bottom of the panel and connect them in **series** using the link wire(s) provided. Connect the batteries to the circuit board via the red (positive) and black (negative) battery leads. (See 'Battery Connection', page 4). The BATTERY/POWER SUPPLY FAULT light will light and the WARNING BEEPER will sound. **Incorrect connection will blow the battery fuse (F5) and MAY DAMAGE THE PANEL.**

Connect the mains wiring and turn the mains supply on. The MAINS ON light will light, the BATTERY/POWER SUPPLY FAULT light will go out and the WARNING BEEPER will silence, providing the batteries are not flat. If the batteries are completely discharged or if they are inferior but still working, the battery fault circuit will still show a fault – check this using new batteries. Please note that a fully charged 24 Volt battery will measure 26 to 28 Volts and that if it measures less than 25 Volts it is almost completely flat. If a battery measures less than 21 Volts it is either totally exhausted or may have a faulty cell.

A battery measuring less than 21 Volts is unlikely to recharge properly and should be replaced. The battery monitoring circuit will show a BATTERY/POWER SUPPLY FAULT, which, if it does not cease, means that the batteries are faulty.

WITH THE KEYSWITCH AT NORMAL

The MAINS ON light is lit. No other lights are lit. No sounders are sounding. The push buttons are inoperative.

TURN THE KEYSWITCH TO ARM CONTROLS

This allows the push buttons to be used by an authorised person but does not otherwise affect the panel.

Press RESET / TEST/ SCROLL. All the Zone Fault Lights will light momentarily and then all the Zone Fire Lights.

The green Mains On led will remain lit.

All the other lights will NOT light.

TEST THE POWER SUPPLY MONITORING CIRCUIT

Switch off the Mains. The BATTERY/POWER SUPPLY FAULT lamp will light, the MAINS ON light will extinguish, and the WARNING BEEPER will sound.

Press SILENCE ALARM/FAULT SOUNDERS and the WARNING BEEPER will silence but the MAINS/BATTERY FAULT light will remain lit.

Reconnect the mains and after a short time the panel will revert to normal.

Disconnect the Battery. After a short time the MAINS/BATTERY FAULT light will light and the WARNING BEEPER will sound.

Reconnect the battery and after a short time the panel will revert to normal (i.e. only the green MAINS lights on).

Note

1) This test should be carried out with a set of new and fully charged batteries – deteriorated cells will show a fault even when connected and charged up.

2) If good but completely discharged cells are used the MAINS/BATTERY FAULT light will stay on for several minutes until the battery obtains sufficient charge.

TEST THE SOUNDER MONITORING CIRCUIT(S)

DO NOT carry out this test with any red FIRE light lit as sounder fuse(s) could blow (F1, F2, F3 or F4). Make sure a small end of line resistor (colour code blue, grey, red, gold) is connected across each of the sounder circuits on terminals (5 & 6, 7 & 8, 9&10, 11&12).

Short the sounder terminals 5 & 6 and keep them shorted. The SOUNDER FAULT light will light and the WARNING BEEPER will sound.

Press SILENCE ALARM /FAULT SOUNDERS and the WARNING BEEPER will silence but the SOUNDER FAULT light will stay on.

Remove the short and the panel will revert to normal.

Open circuit the sounder terminals 5 & 6 by disconnecting one leg of the end of line resistor. The SOUNDER FAULT light will light and the WARNING BEEPER will sound. Press SILENCE ALARM /FAULT SOUNDERS and the WARNING BEEPER will silence but the SOUNDER FAULT light will stay on.

Remake the circuit and the panel will revert to normal.

Repeat the tests for the other sounder circuits.

TEST THE DETECTOR MONITORING CIRCUITS

Make sure an End of Line Device (EOLD) is connected across each pair of Detector Zone terminals (13 & 14, 15 & 16, etc.). This device is polarised and the red wire must be connected to Zone +Ve and the black wire to Zone -Ve.

Five conditions can exist on the detector circuits.

1. **Normal condition:** Current flows round the detector loop via the EOLD to monitor the wiring. Detectors and call points are connected in parallel across the line.
2. **Open Circuit Fault:** The wiring is broken at some point and the monitoring current cannot flow.
3. **A Head Removed Fault condition:** where a head has been removed from its base leaving a diode in circuit. (Required on those systems where Manual Call points are wired in mixed order with detectors and are required to operate when a detector is removed)
4. **Short Circuit Fault:** A short circuit exists at some point and too much monitoring current flows.
5. **Fire condition:** A partial short exists and the monitoring current increases but not enough to show a short circuit fault. Most smoke detectors make a partial short when they are triggered but manual call points and other normally open switches need to have 470 or 680 ohm resistors connected in series in order to give a partial short. (Check - Resistor may be included in Call Point as supplied).

OPEN CIRCUIT FAULT TEST

Open circuit the Zone 1 detector terminals (13 & 14) by disconnecting one wire of the EOLD. The ZONE 1 Fault light will pulse three times.

The Warning Beeper and General Fault light will also pulse. Press SILENCE ALARM /FAULT SOUNDERS and the WARNING BEEPER will silence but the lights will stay on.

Reconnect the EOLD and the panel will revert to normal.

Repeat the test for the other detector circuits.

HEAD REMOVAL FAULT TEST

Open circuit the detector terminals 13 & 14 by removing one leg of the EOLD. Connect a diode in series with the EOLD.

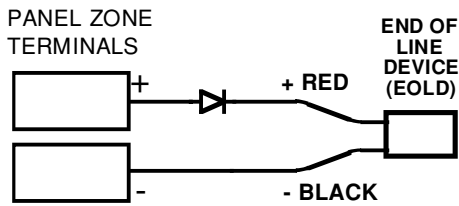

The ZONE 1 FAULT light will pulse twice. The Warning Beeper and General Fault light will also pulse. Press SILENCE ALARM /FAULT SOUNDERS and the WARNING BEEPER will silence but the lights will stay on.

Note that if the diode is in the wrong way round then the panel will show an open circuit fault (the zone fault light will pulse three times). Reconnect the circuit and the panel will revert to normal.

Repeat the test for the other detector circuits.

SHORT CIRCUIT FAULT TEST

Short circuit the detector terminals 13 & 14 and keep them shorted. The ZONE 1 FAULT light will pulse once. The Warning Beeper and General Fault light will also pulse. Press SILENCE ALARM /FAULT SOUNDERS and the WARNING BEEPER will silence but the lights will stay on.

Remove the short and the panel will revert to normal.

FIRE CONDITION

Simulate a Fire condition by connecting and activating a Manual Call point or by fitting a 470 ohm resistor across terminals 13 & 14. The sounder output relay will operate, the ZONE 1 FIRE light will flash – the panel has been triggered and gone into alarm.

Press SILENCE ALARM /FAULT SOUNDERS. The sounder output relay will return to normal and the ZONE 1 FIRE light will light steadily. The WARNING BEEPER will now sound.

Press RESET / TEST/ SCROLL and the panel will go back into alarm as the Fire condition is still present.

Remove the Fire condition.

Press SILENCE ALARM /FAULT SOUNDERS then

RESET / TEST/ SCROLL and the panel will revert to normal.

Repeat the test for the other detector circuits.

Note

1) Pressing RESET / TEST/ SCROLL when in the fire condition (i.e. red lights flashing) has no effect. (The sounders must be Silenced first before Reset is active).

2) When the Alarm Sounders are silenced, (steady red Fire lights), the Fault Beeper will be on and cannot be silenced.

3) Resetting the system from the Silenced Fire state with the fire condition still existing (Call Point or Detector still triggered) will retrigger the alarm.

DISABLE FUNCTION

This function allows the user to Disable the Auxiliary Outputs and/or any or all of the Detector Zones. When the Auxiliary Outputs are disabled they stay in the normal state independent of the Panel Condition, and the Aux Outputs Disabled light will be lit steadily. When the Detector Zones are disabled they will not respond to any condition on that zone, and Zone Fault light will be lit steadily.

To enter the Disable mode press the DISABLE button once. This selects the Aux Outputs. The current selection

indicates its status by flashing if enabled, or steady if disabled. To change the status press DISABLE once, pressing it again will revert to the previous state.

To select another zone press RESET / TEST/ SCROLL.

N.B. If the Auxiliary Outputs are disabled the Fault beeper CANNOT be silenced. To exit the Disable programming mode return the key to Normal.

EVACUATE

Press EVACUATE.

The output relays will activate to operate the sounders.

The GENERAL FIRE light will pulse. Press SILENCE ALARM / FAULT SOUNDERS, and the relay will return to the normal state.

The GENERAL FIRE light will now be steady and the WARNING BEEPER will be active.

Press RESET / TEST/ SCROLL to return the panel to normal state.

If you wish these tests can be carried out with a sounder and smoke detector and a call point from each circuit connected into each pair of terminals and the end of line resistors fitted to them.

■ ANCILLARY FACILITIES

TEST FACILITIES (SEE FIGURE 7 FOR LINK POSITIONS)

Whilst the panel is in any of the following test setups the GENERAL FAULT led will be lit continuously, the Warning Sounder will be active and cannot be silenced. The Auxiliary Fire and Fault expansion outputs are **disabled**.

ONE MAN TEST (NON-LATCH TEST) FACILITY (OMT)

This is a non-latching test facility which allows manual call points and automatic smoke detectors to be tested and to reset automatically. To set this facility link the plug marked OMT on PLK1 and the adjacent LED will light and the WARNING BEEPER will sound and cannot be silenced. When the panel is triggered the alarm sounders will operate for one second and will silence for eight seconds approximately before resounding. During the latter period the detector circuits are reset. This cycle will continue until the cause of the alarm is removed by the smoke clearing from a detector, or the call point being reset. When testing is complete, remove the link.

SOUNDER WALK TEST FACILITY (SWT)

This test facility aids checking the sounders in each area of the building without continuous annoying activation. To set this facility link the plug marked SWT on PLK1 and the adjacent LED will light and the fault beeper will sound and cannot be silenced. This facility activates a cycle where the alarm sounders operate for 1 second and then remain silent for 10 seconds approximately. When testing is complete, remove the link.

CONFIGURATION FACILITIES

DELAYED SOUNDERS

This facility sets a delay of 30 seconds from the panel being triggered from any zone to the activation of the alarm sounders. Used in clubs etc where the nuisance or panic caused must be avoided. This delay can be overridden by momentary activation of the EVACUATE button, which is automatically armed during this delay period even with the keyswitch in the Normal position.

This facility must only be used with approval of the Fire officer.

During the delay period panel lights will indicate the triggered Zone(s) and the Fault Beeper will sound with an urgent tone. The panel can be Silenced then Reset during the delay period before the Sounders are activated.

To set this facility link the plug marked DS on PLK1.

TO REVERT TO 1980 BS.

This facility overrides the short circuit fault monitoring sensing and allows the panel to be used on older installations which do not have 470 ohm Call Point Resistors fitted and produce a short circuit Fire condition when activated.

To set this facility link the plug marked S on PLK3 (PLK1 on Zone Cards) on the required zone(s).

NON LATCHING FACILITY

This facility changes the function of zones such that when the cause of trigger has been removed (E.g. Manual Call point reset) then zone status at the panel is returned to Normal rather than staying in the Fire state .

To set this facility link the plug marked N on PLK3 (PLK1 on Zone Cards) on the required zone(s).

AUX 24V +VE

This output is a regulated but unmonitored output fused at 1A (F6). With PLK2 (adjacent relay) linked in position A this output is continuous. If PLK2 is linked in position B then the output is present when the panel is normal but is switched off when the relay is activated.

This facility can be used to provide a fail-safe output, that "switches off" when the sounders are activated or if the power to the panel fails. Note that any load provided by this output increases the quiescent drain on the panels supply which in turn affects the stand-by time of the system.

It is not intended to supply door release systems (see below)

VOLTAGE FREE RELAY CONTACTS

These single pole relay outputs available via 2 (normally closed), 3 (common), and 4 (normally open) in the base connections change over when the sounders are activated. They **must not** be used to switch mains potentials, being rated at 30vD.C. and 1.0A.

Note about Holding Magnets (Magnetic Door Retainers)

BS5839 Pt1 1988 states that devices which draw current & hence would reduce the battery stand-by time (minimum 24 Hours plus 1/2 hour of full alarm load) must not be fitted. We therefore recommend that either:-

- 1) 24 Volt holding magnets should use a separate 24 Volt power supply under control of the panel. Ideally the separate supply should be of a "Hold off" type that requires very little control current
- 2) 240 Volt holding magnets should be used, in which case a separate mains power switching 24 Volt coil relay, powered from the panel, should be used.

Special polarised relays and PSUs are available for connecting to either the sounder circuits, or to Auxiliary Fire Outputs (see page 8), to allow control of Door Release systems.

FIGURE 7

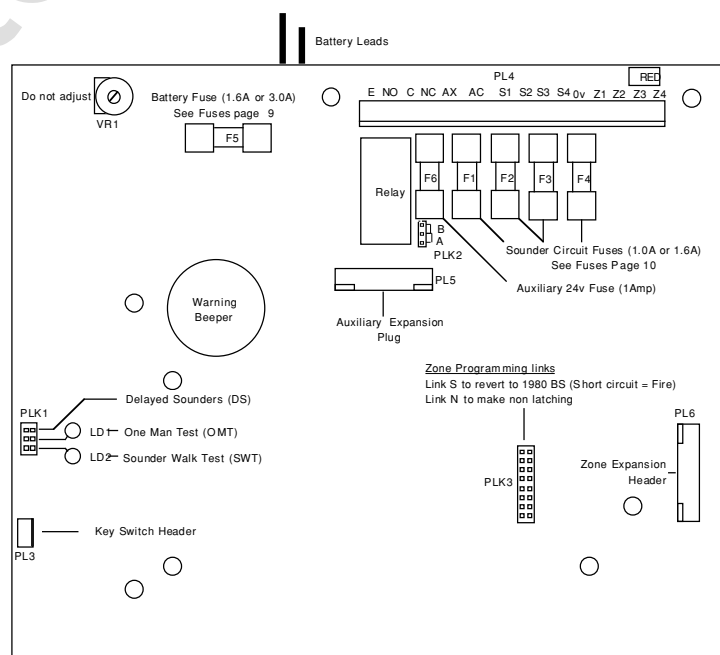

AUXILIARY EXPANSION PLUG

This range of panels provides Auxiliary Expansion Input and Outputs to interface with external equipment. Two Fire outputs and a Fault output are provided. These are of open collector type. These outputs can be disabled via the DISABLE function (see page 6).

A "Class change" input is provided that will activate the alarm sounder outputs from an external command.

Connections are made via the Ancillary Connections "A" to "F" in the base of the panel. The connections are then transferred to PL5 (adjacent relay) on the main PCB by FF574X Expansion Loom (not included)

The Ancillary Connections "A" to "F" are as follows:

AUXILIARY FIRE OUTPUT 1 (A)

This output is activated when the alarm sounders are activated in a Fire condition.

AUXILIARY FIRE OUTPUT 2 (B)

This output is activated in a Fire condition, whether the alarm sounders are activated or not. i.e. it is activated immediately when a Fire condition is detected, even in the delayed sounders mode. This output remains activated in a Silenced Fire state, until the panel is Reset.

AUXILIARY FAULT OUTPUT (C)

This output is activated in any Fault condition. When all Faults are cleared then the Fault output is deactivated.

EXTERNAL SOUNDER ACTIVATE ("CLASS CHANGE") (D)

This normally open input when shorted to 0v activates the relay to activate the Alarm Sounder circuits. When the short is removed the sounders are reset.

No panel indication is given during the sounder activation.

0V SUPPLY (E) AND 24V (F)

Supply outputs for use with the above.

APPLICATIONS FOR AUXILIARY INPUTS AND OUTPUTS

The outputs are typically used to drive relays external to the panel. The relays may for example be used to control ventilation systems, gas valves, door release systems etc. The External Sounder Activate may be used to interface to other panels or may be controlled by a time switch to give a momentary warning of a timed event via the alarm sounders throughout a building (check with the Fire officer that this is permissible).

There is no restriction on the choice of relays other than if driven directly from the panel they must have a 24v coil and the current must not exceed the Auxiliary output capability (see page 10), and if they are switching mains potentials that the load is suitably isolated from the Fire Panel drive circuits.

If the coil current is derived from the panel it will affect the stand-by time of the system. The worst case is that of the Fault relay which will be energised for the whole time the mains supply has failed.

CIRCUIT EXAMPLES

The circuit below shows an example of a general arrangement where all outputs and inputs are used.

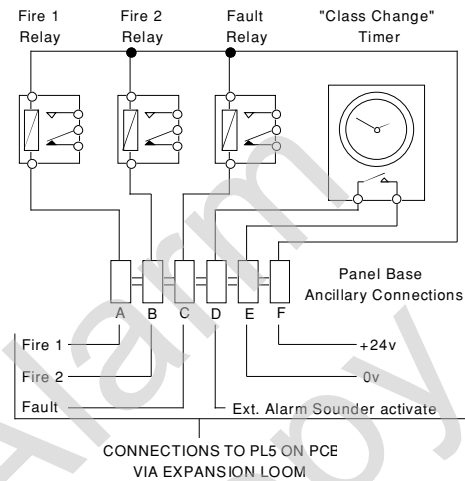

FIRE PANEL INTERCONNECTION

Shown below is an example many MFP Panels may be interconnected so that any panel that is triggered into an alarm state can then activate the alarm sounders on all the other panels via a common 2 wire connection. The wiring between the panels must have less than 100Ω impedance between the furthest points and no other connections should be made to the pair.

In addition each panel has a relay connected to Aux. Fire 2 in order to switch a Strobe light (for example) from a local supply. In this case the light would only be illuminated if that particular panel was in an alarm state, but not if triggered externally. All the Alarm Sounders are Silenced from the triggered panel only. After Silencing the light stays lit until the panel is Reset.

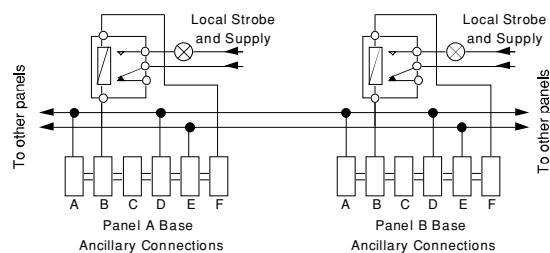

■ TROUBLESHOOTING

Before attempting any of the following disconnect the mains and batteries.

The mains must be isolated whilst the lid is open.

MANUAL CALL POINTS AND NORMALLY OPEN SWITCHES CAUSE A SHORT CIRCUIT FAULT WHEN TRIGGERED

A call point resistor has not been fitted in series at each call point or switch. A resistor MUST be fitted as the British Standard requires short circuit monitoring facility from 1st January 1990.

MANUAL CALL POINTS, ECONOMY HEAT DETECTORS, OR SMOKE DETECTORS TRIGGER, BUT DO NOT CAUSE A FIRE CONDITION

Either the wrong value call point resistor has been fitted in series at the call point or detector or a resistor is already fitted inside. If you have fitted a resistor try shorting it out and re-testing the device. To check the zone is OK, remove all wiring from the panel and re-insert an EOLD (End of Line Device) to give a normal condition. Then simulate a fire condition on the zone with a 470 to 680 Ohm resistor. If the zone goes into fire the device under test may be out of specification.

RESET / TEST / SCROLL BUTTON DOESN'T RESET THE PANEL FROM FIRE CONDITION

Press SILENCE first.

RESET / TEST / SCROLL BUTTON STILL DOESN'T RESET THE PANEL

Either a call point is triggered in which case replace the glass or if an older bi-metal heat detector has triggered, wait for it to cool down and reset itself.

A smoke detector may be faulty and will not unlatch, in which case the LED on the detector may not be lit and you can only find the offending device by following logical tests. Start by removing the wiring and refitting the EOLD in the panel to prove the panel is OK. Then reconnect the wiring and EOLD, and set the panel in the One Man Test (OMT) mode (page 7). Starting at the end of the line, remove each detector in turn. When you reach the faulty device the panel will remain reset. Remove the OMT link when the test is complete.

THE BUZZER SOUNDS AND THE GENERAL FAULT LIGHTS IS LIT STEADILY

The panel has been left in a test mode. Remove the link(s) on PLK1.

PERMANENT BATTERY/POWER SUPPLY FAULT

1. Is the MAINS ON light illuminated? If not, check the mains supply and fuse (adjacent to Transformer).
2. Check the battery supply (RED lead to +Ve terminal, BLACK lead to -Ve terminal). If the battery leads have been connected the wrong way round the battery fuse (F5) will blow but a permanent power fault may have been caused which CANNOT be reset. The fault is factory detectable and is not covered by the warranty.

Consult your dealer.

3. Check two 12 Volt batteries of the relevant size are connected in series.
4. Check the wiring loom is pushed on properly to PL4.
5. Check the transformer leads are pushed on to the tags on the transformer properly.
6. If the MAINS ON & BATTERY/POWER SUPPLY Fault lights are still lit, the batteries are heavily discharged or

have failed - try a new pair, even new batteries have been known to fail.

PERMANENT ZONE FAULT

N.B. The number of pulses of the Zone Fault light indicates the fault type. 1 Pulse = Short Circuit, 2 = Head removed, 3 = Open Circuit. If the light is steady then the zone is Disabled (see page 6).

Disconnect the relevant zone completely and refit the EOLD at the panel. If the fault condition clears then there is a wiring fault. Double check and refit the wiring and EOLD on the zone and trace the fault with consideration for the type of fault indicated.

A common fault is a detector badly seated in a base, that has not properly made connection.

If the fault is a Head removed and all the heads are fitted then check that a resistor has not been fitted by mistake in place of the EOLD. N.B. Badly fitted heads without diodes fitted will show an O.C Fault.

INCORRECT RESPONSE WHEN HEAD REMOVED

Zone Fault led shows 3 pulses = Open circuit. The continuity diode is either not fitted, is fitted in reverse or is faulty. If this is the case then Manual Call points after the removed detector will not respond when activated.

Refit correctly (See fig 4, page 4) or replace the diode.

If no fault is indicated when a head is removed and the diode is fitted correctly then there is an incompatibility problem with the panel and heads or the cables. Consult your dealer.

PERMANENT SOUNDER FAULT

Check the Sounder fuses (F1, 2, 3 & 4) on the pcb and replace if necessary.

Check the correct end of line resistor (6800 Ohms; blue, grey, red, gold) has been fitted. Disconnect the relevant zone from the terminal block and refit the end of line resistor only. If the fault condition clears there is a wiring fault.

BUTTONS DON'T WORK

Turn the keyswitch to ARM controls and press SILENCE ALARM/FAULT SOUNDERS and then RESET / TEST / SCROLL. If the fault persists, check the plug assembly from the keyswitch (PL3) is seated correctly on pcb.

PROCESSOR FAULT LIGHT LIT

Accompanied by permanent Fault beeper tone.

This state indicates that the panels microprocessor has failed to execute its programme correctly and that a safety circuit has operated to restart the programme. This can be caused by sudden interruption of all power, high powered interference (e.g. lightning strike) or misconnection or failure of circuit boards and peripheral equipment.

To stop this fault warning turn the keyswitch to ARM controls and press RESET / TEST / SCROLL.

If the Processor Fault light comes on again, check the connections between the system circuit boards, and that the power supply is not faulty. If this fault persists then the panel must be returned to your dealer for investigation.

N.B. If the microprocessor is restarted (after a fault or when the panel is powered up) then any functions that were disabled will now be enabled. (A fail-safe feature).

IF ANY FAULT CONDITION PERSISTS CONSULT YOUR DEALER

MFP RANGE *panel specifications*

EXTERNAL INDICATORS

- General Fire. ■ Mains On.
- General Fault. ■ Zone Fire.
- Zone Fault (indicates short circuit, head out, open circuit and zone disabled).

■ Sounder Fault. ■ Processor Fault.

- Battery / Power Supply Fault.
- Aux. Outputs Disabled.
- Fault Sounder (indicates fault, silenced fire and delayed alarm sounders).

USER CONTROLS

- Reset / Test Scroll.
- Silence Alarm / Fault Sounders.
- Evacuate.
- Disable.

ENGINEER CONTROLS

- One Man Detector Test.
- Sounder Walk Test.
- Sounder Isolate.
- Sounder Delay.

	MFP 4 / 8 / 12 (1.4A SUPPLY)	MFP 4 / 8 / 12 / 16 / 20 / 24 / 28 (3.0A SUPPLY)
POWER SPECIFICATION		
MAINS SUPPLY VOLTAGE	230 Va.c. ±10% 50/60Hz	230 Va.c. ±10% 50/60Hz
INTERNAL POWER SUPPLY	27Vd.c.	27Vd.c.
TOTAL OUTPUT CURRENT LIMITED TO	1400 mA @ 240 Va.c.	3000 mA @ 240 Va.c.
AUXILIARY POWER OUTPUT	27 Vd.c. Nominal	27 Vd.c. Nominal
MAINS SUPPLY MONITORED FOR FAILURE	YES	YES
BATTERY CHARGER MONITORED FOR FAILURE	YES	YES
BATTERIES MONITORED FOR DISCONNECTION AND FAILURE	YES	YES
DETECTOR CIRCUIT SPECIFICATION		
NUMBER OF CIRCUITS	4-12	4-28
LINE FAULT MONITORED FOR OPEN CIRCUIT	YES	YES
LINE FAULT MONITORED FOR SHORT CIRCUIT	YES (Can be disabled for each zone)	YES (Can be disabled for each zone)
LINE FAULT MONITORED FOR DETECTOR REMOVAL	YES	YES
END OF LINE DEVICE	Miniature Circuit Board	Miniature Circuit Board
DETECTOR CONTINUITY DIODES	1N4001 or Schottky	1N4001 or Schottky
CALL POINT RESISTOR VALUE	470 - 680 ohm 0.5Watt	470 - 680 ohm 0.5Watt
MAXIMUM NUMBER OF SMOKE DETECTORS PER ZONE	20 (based on a total detector current of 2mA, each detector consuming 100µA, and a total voltage drop of 12V with 20 silicon diodes when all detectors are removed).	
MAXIMUM NUMBER OF MANUAL CALL POINTS PER ZONE	No limit	No limit
SOUNDER CIRCUIT SPECIFICATION		
NUMBER OF CIRCUITS	4	4
END OF LINE RESISTOR VALUE	6800 Ω 5% Tol. 0.25W (blue, grey, red, gold)	6800 Ω 5% Tol. 0.25W (blue, grey, red, gold)
LINE FAULT MONITORED FOR OPEN CIRCUIT	YES	YES
LINE FAULT MONITORED FOR SHORT CIRCUIT	YES	YES
OUTPUTS FUSED AT	1 Amp	1.6 Amp
MAXIMUM TOTAL OUTPUT CURRENT ALL OUTPUTS	1400 mA	3000mA
MAXIMUM NO OF BELLS @ 25 mA	56	120
MAXIMUM NO OF ELECTRONIC SOUNDERS @ 20 mA	70	150
AUXILIARY RELAY CONTACTS(DO NOT CONNECT MAINS VOLTAGES)	1A 30 Vd.c. max Voltage Free	1A 30 Vd.c. max Voltage Free
FUSES - ALL FUSES COMPLIANT TO IEC (EN60127 PT2)		
MAINS TERMINAL BLOCK	400mA T 20mm	630mA T 20mm
SOUNDER OUTPUTS F1,F2,F3,F4	1A F 20mm	1.6A F 20mm
AUXILIARY OUTPUT F6	1A F 20mm	1A F 20mm
BATTERY FUSE F5	1.6A F 20mm	3A F 20mm
AUXILIARY FIRE AND FAULT OUTPUTS		
OUTPUT TYPE	Open Collector	Open Collector
MAX SINK CURRENT	100mA Each	100mA Each
MAX OPEN CIRCUIT VOLTAGE	27Vd.c.	27Vd.c.
DOOR RETAINING MAGNETS	DO NOT USE PANEL POWER SUPPLY AS YOU WILL DRASTICALLY REDUCE BATTERY STAND-BY TIME	
CONNECTION BLOCK		
LARGEST ACCEPTABLE CONDUCTOR SIZE	2.5 mm ²	2.5 mm ²
SMALLEST ACCEPTABLE CONDUCTOR SIZE	0.75 mm ²	0.75 mm ²
DIMENSIONS		
ENCLOSURE (WIDTH x HEIGHT x DEPTH)	405 x 267 x 92mm	521 x 334x 140mm
BATTERY VOLUME DIMENSIONS (WIDTH x HEIGHT x DEPTH)	310 x 110 x 67mm	350 x 110 x 105mm
WEIGHT (WITHOUT BATTERIES)	5.0 Kg	9.5 Kg
ANCILLARIES (Individual datasheets available on request)		
TWO WIRE (POWER & DATA) REPEATERS (Offering full control, except isolate).	One interface card allows the connection of up to 8 monitored Repeaters. Can be star or daisy chain wired.	
4 ZONE MONITORED SOUNDER EXTENDER KITS	Connects to existing sounder circuits to provide four additional monitored sounder circuits.	
FLUSH BEZELS	Available in two different sizes to fit all variants of master panel and repeater metalwork.	

QUIESCENT CURRENT / BATTERY STAND-BY TIME (HRS)

NUMBER OF ZONES	4	8	12	16	20	24	28	
QUIESCENT CURRENT (mA)	45	60	75	90	105	120	135	The quiescent currents are given for the following conditions - No mains supply, fault beeper active, no aux. output connections, end of line devices and resistors only fitted to detector and sounder loops. The battery stand-by times are guidelines only based on the above conditions. Additional loads that increase the quiescent current in the normal state and sounder loads must be considered when calculating stand-by time. Batteries in poor condition greatly reduce stand-by time.
STAND-BY (HRS) BATT. SIZE 2.0	40	30	25	20	18	16	14	
STAND-BY (HRS) BATT. SIZE 2.6	55	40	35	30	25	22	19	
STAND-BY (HRS) BATT. SIZE 6.0	130	100	80	65	55	50	45	
STAND-BY (HRS) BATT. SIZE 10.0	220	165	130	110	95	80	75	
STAND-BY (HRS) BATT. SIZE 12.0	260	200	160	130	110	100	85	

After completing and testing the fire alarm system the following certificate must be completed and handed to the occupier together with the Log Book which also requires completion where indicated.

CERTIFICATE OF INSTALLATION AND COMMISSIONING OF A FIRE ALARM SYSTEM AT:-

Protected area _____

Address _____

My attention has been drawn to the recommendations of BS5839: Part 1 clause 29, relating to servicing the system. In accordance with BS5839: Part 1: 1988, subclause 26.1, record drawings and operating instructions have been supplied and received by:

Signed _____ Status _____ Date _____

For and on behalf of (user) _____

In accordance with BS5839: Part 1: 1988, subclause 26.2, the installation has been inspected for compliance with the recommendations of the code.

In accordance with BS5839: Part 1: 1988, subclause 26.3, the insulation of cables and wires has been tested.

In accordance with BS5839: Part 1: 1988, subclause 26.4, the earthing has been tested.

In accordance with BS5839: Part 1: 1988, subclause 26.5, the entire system has been tested for satisfactory operation.

In accordance with BS5839: Part 1: 1988, subclause 26.6, it is certified that the installation complies with the recommendations of the code, other than the following deviations:-

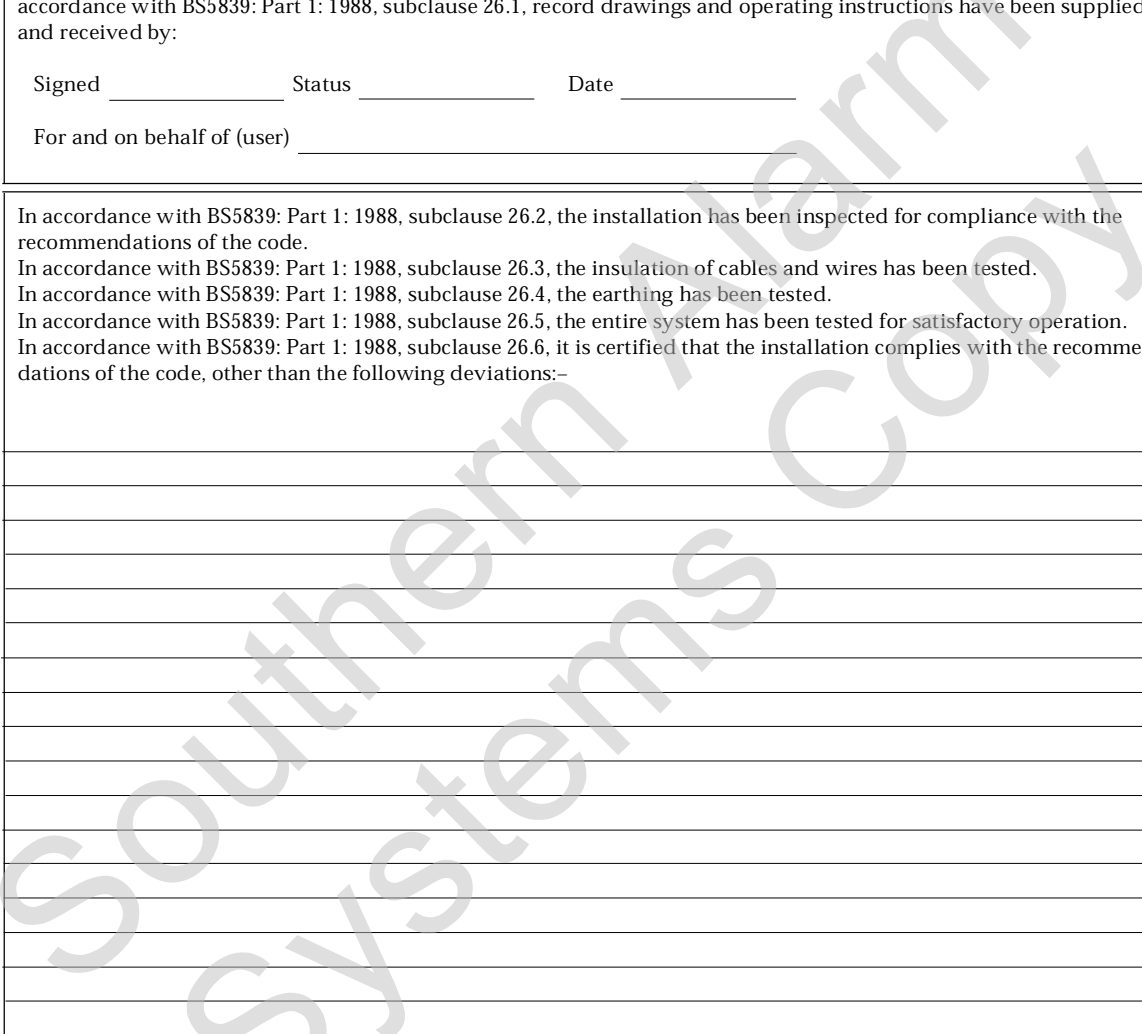

Signed (Commissioning engineer) _____ Date _____

For and on behalf of _____

The system log book is situated _____

The system documentation is situated _____

The system keys are kept by _____

SYSTEM INSPECTION

This is a requirement of BS5839 Pt 1: 1988 "Fire Detection and Alarm Systems for Buildings" and should be carried out by person(s) responsible for supervising the system.

DAILY INSPECTION

Check the MAINS ON light is lit. Check no other lights are lit or sounders operating. Notify any faults to the installer.

WEEKLY TEST

Turn the Keyswitch to ARM CONTROLS and press RESET / RESOUND / TEST ZONE LAMPS. Check that all zone lights show and that the WARNING BEEPER sounds. Operate a call point or sensor to test the fire alarm. Check that the alarm sounders operate. Reset the fire alarm by pressing SILENCE and then RESET / RESOUND / TEST ZONE LAMPS (Two people may be needed for this test). Each week test a different zone (if applicable). Also use a different call point or sensor for each test, so that all call points and sensors are tested in rotation. A building plan detailing the call point / sensor location is recommended. Check all call points and sensors and verify that none is obstructed in any way.

QUARTERLY TEST

Check all previous Log Book entries and verify that remedial action has been taken. Visually inspect the battery and its connections. Operate a call point or sensor in each zone to test the fire alarm as in the weekly test above. Remove the mains supply and check that the battery is capable of supplying the alarm sounders.

ANNUAL TEST

As for the weekly and quarterly tests but check every detector, call point, sounder and all auxiliary equipment for correct operation.

EVERY 2-3 YEARS

Clean the smoke detectors to ensure correct operation and freedom from false alarms. Special equipment is required for cleaning smoke detectors. Consult your supplier if in doubt.

EVERY 4 YEARS

Replace sealed lead acid batteries.

Any defects noted in the above tests should be noted in the log book and appropriate remedial action taken.

SERVICING

REGULAR SERVICING IS STRONGLY RECOMMENDED, preferably on a continuous maintenance contract by a competent organisation. A full itemised report on every part of the installation should be obtained at least annually.